

EFCW03

Coprivaso avvolgente rallentato in termoindurente con cerniere a sgancio rapido cromo

EFCW03OR

Coprivaso avvolgente rallentato in termoindurente con cerniere a sgancio rapido oro

Complementi: Vaso sospeso Efi (EF118)
 Vaso Efi (6010 - 6011)
 Vaso monoblocco Efi (6001 - 6002)
 Vaso Efi back to wall (EF117)
 Vaso Efi Plus (EF117R)

Dim. Imballo - cm | Peso 3 kg | Pz. Pallet n° -

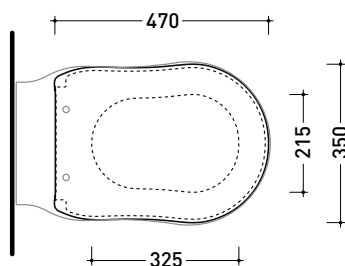

art. EF117 - EF117R
 vista zenitale / zenital view

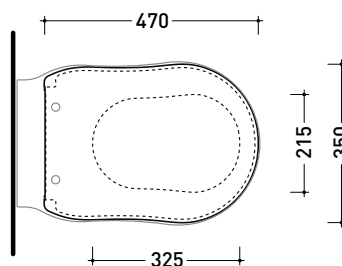

art. EF118
 vista zenitale / zenital view

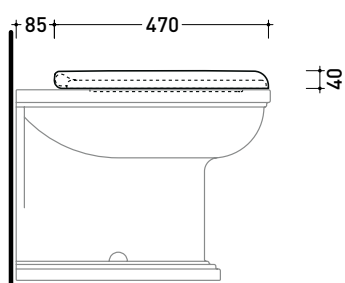

art. EF117 - EF117R
 vista laterale / lateral view

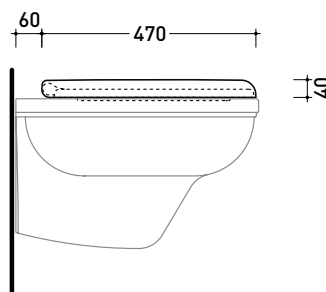

art. EF118
 vista laterale / lateral view

EFCW03

Coprivaso avvolgente rallentato in termoindurente con cerniere a sgancio rapido cromo

EFCW03OR

Coprivaso avvolgente rallentato in termoindurente con cerniere a sgancio rapido oro

Complementi: Vaso sospeso Efi (EF118)
 Vaso Efi (6010 - 6011)
 Vaso monoblocco Efi (6001 - 6002)
 Vaso Efi back to wall (EF117)
 Vaso Efi Plus (EF117R)

Dim. Imballo - cm | Peso 3 kg | Pz. Pallet n° -



pag. 2/2

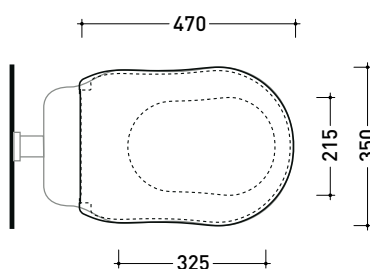

art. 6010 - 6011
 vista zenitale / zenital view

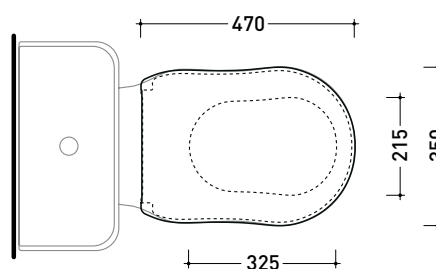

art. 6001 - 6002 / 6003
 vista zenitale / zenital view

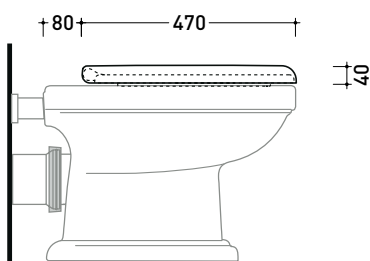

art. 6010 - 6011
 vista laterale / lateral view

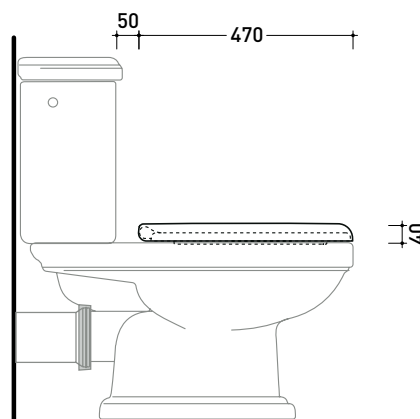

art. 6001 - 6002 / 6003
 vista laterale / lateral view

dimensioni in mm