

2022

CKD109 L 50 x P 50 x H 78,5

Base a terra - 2 ANTE

TOP ESCLUSO

Complementi: Specchi linea FLAG, MADRE

Dim. Imballo

Peso 25,2 kg

Pz. Pallet n° -

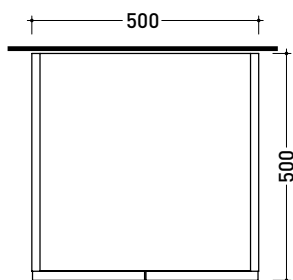

vista zenitale / zenital view

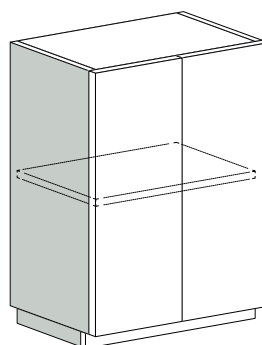

assonometria / axonometry

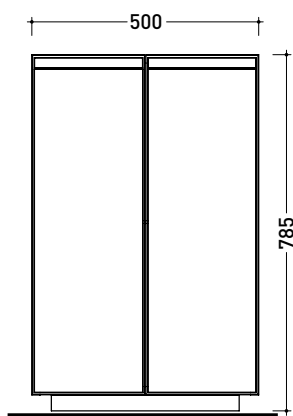

vista frontale / frontal view

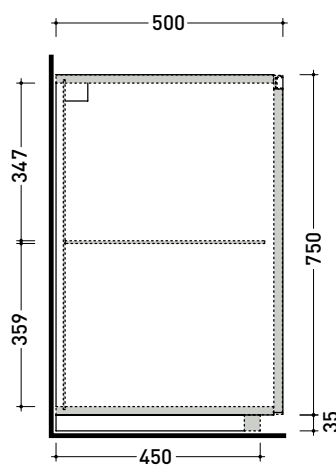

sezione longitudinale / section

dimensioni in mm

2022

CKPR51 L50 a max 270 x P 51 x H 1,2

Piano di copertura in legno da cm 50 a 270
per BASI PORTALAVABO e BASI prof. 37 cm

ATTENZIONE:

Flaminia può forare il piano per l'alloggiamento di lavabi d'appoggio solo in corrispondenza dell'asse centrale della **BASE PORTALAVABO** sottostante.



CE

vista zenitale / zenital view

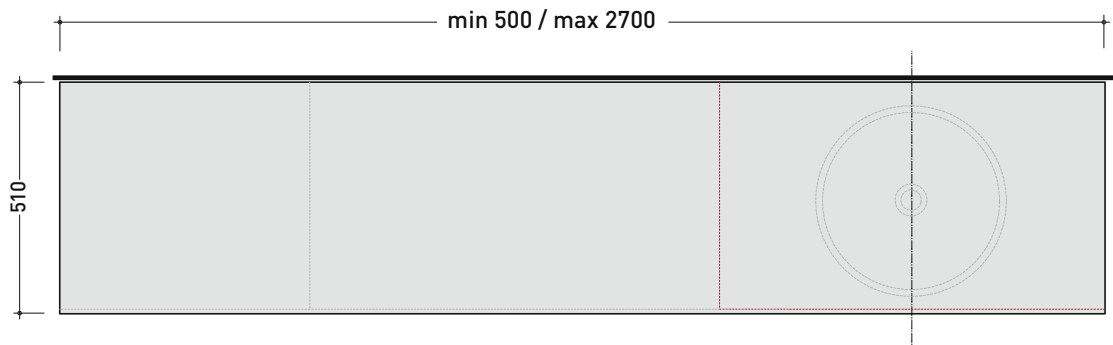

vista frontale / frontal view

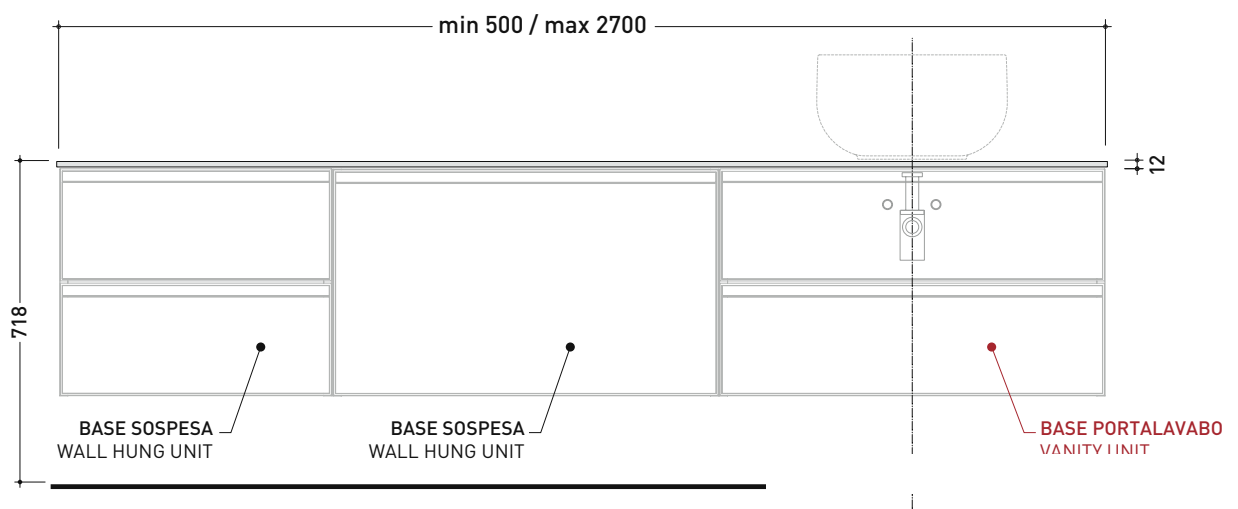

dimensioni in mm

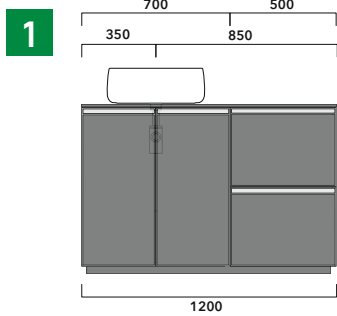

1 | profondità cm 50:
n.1 CKD910 + n.1 CKD152 + CKPR51 cm 120

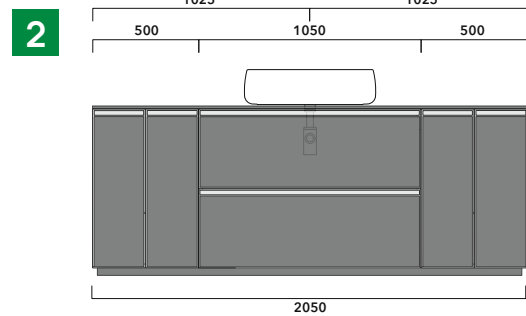

2 | profondità cm 50:
n.2 CKD109 + n.1 CKD754 + CKPR51 cm 205

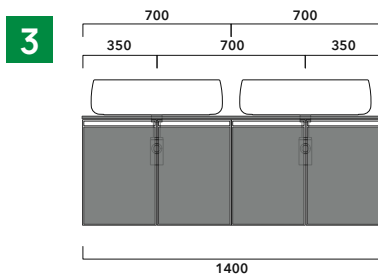

3 | profondità cm 50:
n.2 CKD803 + CKPR51 cm 140

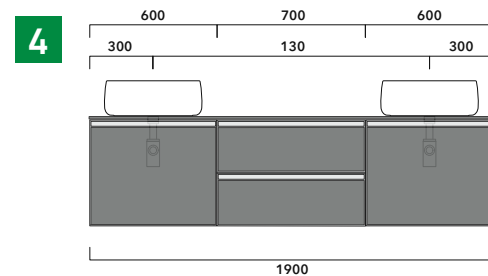

4 | profondità cm 50:
n.1 CKD801 + n. 1 CKD425 + CKPR51 cm 190

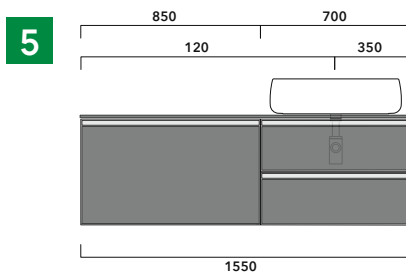

5 | profondità cm 50:
n.1 CKD487 + n.1 CKD809 + CKPR51 cm 155

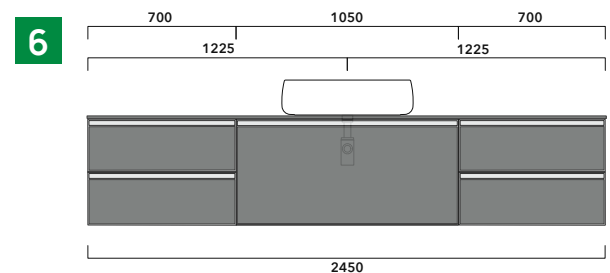

6 | profondità cm 50:
n.2 CKD425 + n.1 CKD893 + CKPR51 cm 245

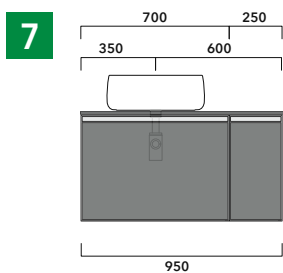

7 | profondità cm 50:
n.1 CKD876 + n. 1 CKD401 + CKPR51 cm 95

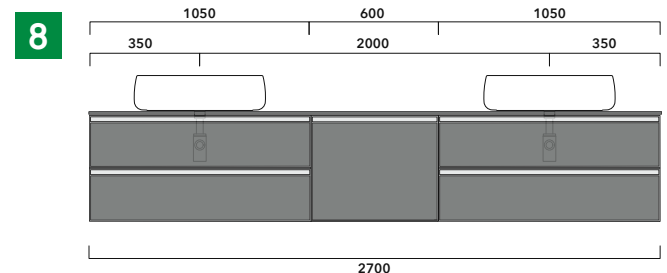

8 | profondità cm 50:
n.2 CKD839 + n. 1 CKD621 + CKPR51 cm 270

→ FLAMINIA. MODULO PER LA REALIZZAZIONE DELLE COMPOSIZIONI MOBILI CUBIKA CUSTOMIZED COMPOSITION FORM FOR CUBIKA UNITS



E' obbligatorio fotocopiare questa pagina, compilarla con cura e allegarla all'ordine.
It is compulsory to photocopy this page, carefully fill in and attach to the order.

» 1 DETTAGLI ORDINE / ORDER DETAILS

ordinante - buyer

cliente - client

ordine - order n:

data - date:

ref.:

annotazioni - notes

» 2 PROFONDITÀ MOBILE / UNIT DEPTH

É importante consultare il listino prezzi / It's important to consult price list

CM 37

CM 50

» 3 DISEGNO / DRAWING

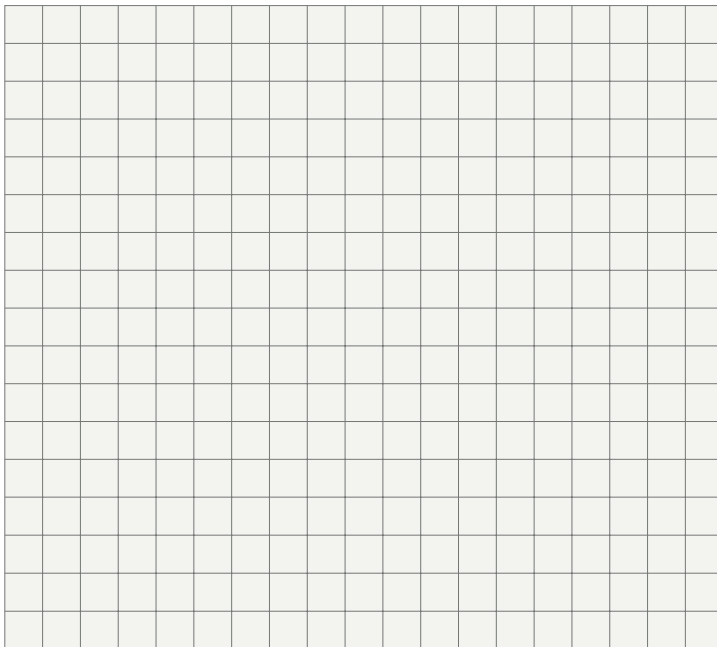

» 4 ELENCO ARTICOLI / ARTICLE LIST

É importante consultare il listino prezzi
It's important to consult price list

n. art. dim.

n. art. dim.

n. art. dim.

n. art. dim.

n. art. dim.

n. art. dim.

n. art. dim.

IMPORTANTE: per il mobile con una sola anta
specificare se è cerniera sinistra o destra
IMPORTANT: for cabinet with one door specify
whether it is left or right hinge

» 5 LAVABO DA APPOGGIO / COUTERTOP BASIN

FLAMINIA lavabo/basin art. _____

NO FLAMINIA lavabo/basin
(allegare scheda tecnica / enclose a technical drawing)

» 6 FINITURA TOP / FINISH TOP

essenze legno / wood:

GRES:

legno laccato opaco / mat lacquered wood:

EUCALIPTO

FOKOS SALE

BIANCO

TAUPE

BORDEAUX

NOCE GRECA

FOKOS TERRA

GREY

CIPRIA

VERDE PALUDE

ROVERE NAT. GRECA

JUTA

ROSA VINTAGE

» 6 SCELTA FINITURA / FINISH SELECTION

essenze legno / wood:

GRES:

legno laccato opaco / mat lacquered wood:

EUCALIPTO

FOKOS SALE

BIANCO

TAUPE

BORDEAUX

NOCE GRECA

FOKOS TERRA

GREY

CIPRIA

VERDE PALUDE

ROVERE NAT. GRECA

JUTA

ROSA VINTAGE