

FY40PC + MW40SP

Varnished extra_light crystal top from 80 to 200 cm
suitable for Miniwash 40 under-counter basin (fixing brackets included)

Complements: **MINIWASH 40** under-counter basin (MW40SP)
FLAG mirrors
MADRE mirror



Package dim.

Weight

Pz. Pallet n° -



vista zenitale / zenital view

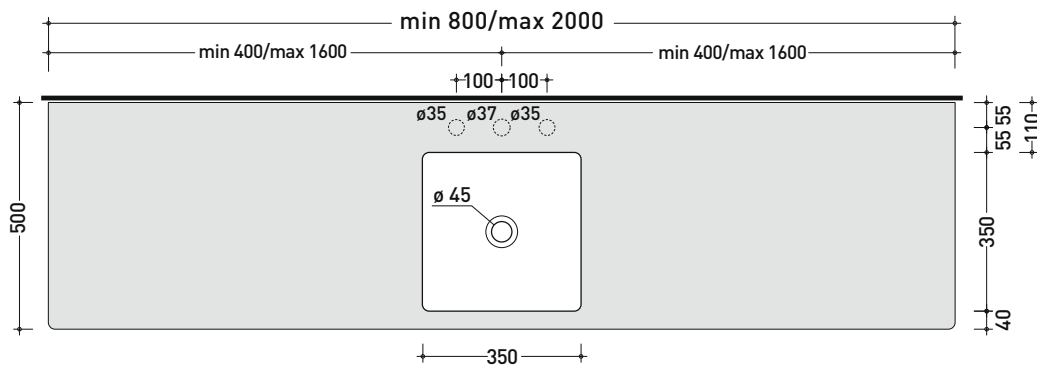

vista frontale / frontal view

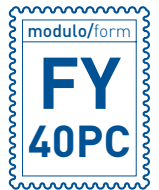
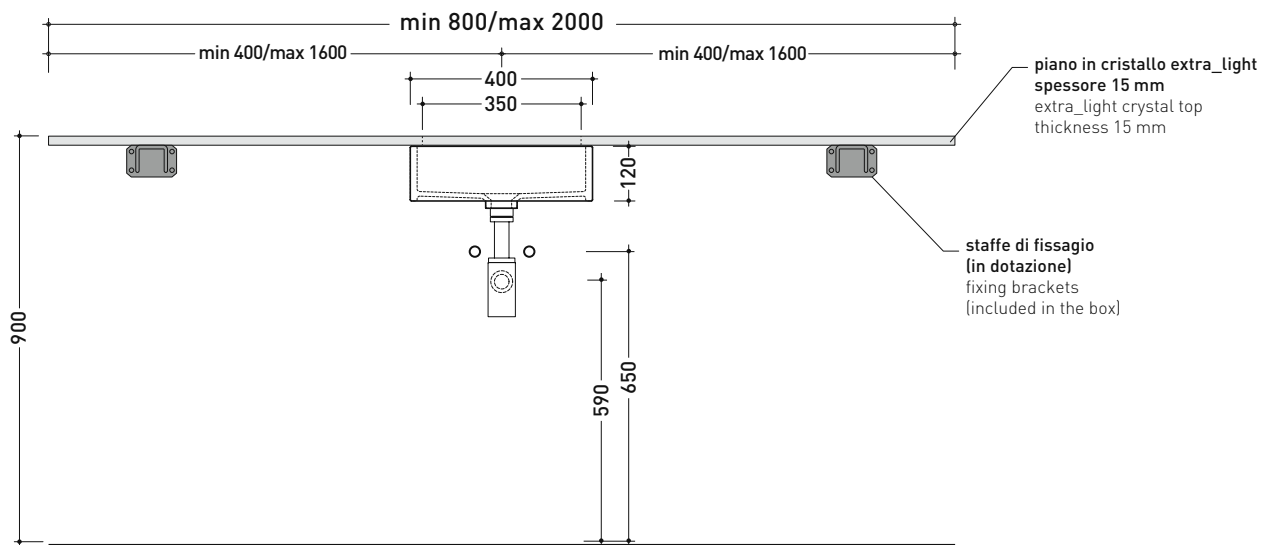

REFERENCE TO
THE COMPULSORY
ORDER FORM

sizes in mm

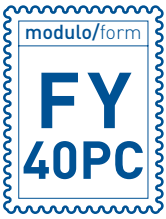

MODULO PER LA REALIZZAZIONE DEI PIANI IN CRISTALLO **FLY** A MISURA PER ART. **MW40SP**
FLY CUSTOMIZED CRYSTAL SHELVES FOR ART. MW40SP FORM

E' obbligatorio fotocopiare questa pagina, compilarla con cura e allegarla all'ordine.
 Is compulsory to photocopy this page, carefully fill in and attach to the order.

» **1** DETTAGLI ORDINE / ORDER DETAILS

ordinante - buyer _____ cliente - client _____

ordine - order n: _____ data - date: _____ ref.: _____

annotazioni - notes _____

» **2** SCELTA ARTICOLO / ITEM CHOICE

E' importante consultare prima la scheda tecnica relativa
 It's important to consult before the technical detail

art. **FY40PC**
 mensola / shelf da / from **80 a / to 200 cm**

» **3** SCELTA COLORE / COLOUR SELECTION

CRISTALLO EXTRA_LIGHT
 EXTRA_LIGHT CRYSTAL

bianco - white nero - black

» **4** SCELTA DETTAGLI / DETAILS SELECTION

FORI RUBINETTERIA / TAP HOLES

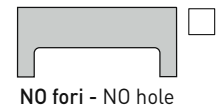
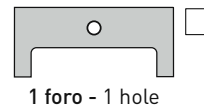
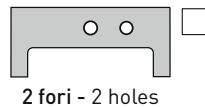
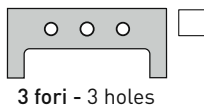

» **5** SCELTA MISURE / MEASURES

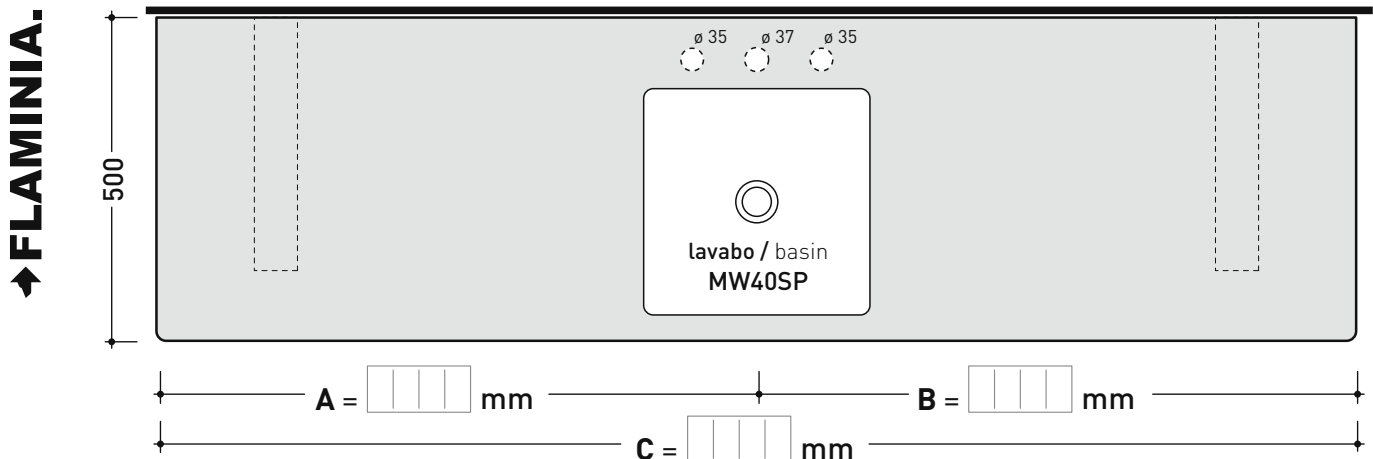

- **A** = misura interasse lavabo da sinistra / left distance of basin.
- **B** = misura interasse lavabo da destra / right distance of basin.
- **C** = misura totale del piano / total length of the shelf.
- verificare sempre che / verify that: **A + B = C**.

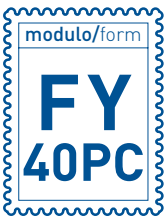

MODULO PER LA REALIZZAZIONE DEI PIANI IN CRISTALLO **FLY** A MISURA PER DOPPIO ART. **MW40SP**
FLY CUSTOMIZED CRYSTAL SHELVES FOR DOUBLE ART. MW40SP FORM



E' obbligatorio fotocopiare questa pagina, compilarla con cura e allegarla all'ordine.
 Is compulsory to photocopy this page, carefully fill in and attach to the order.

➔➔ **1** DETTAGLI ORDINE / ORDER DETAILS

ordinante - buyer _____ cliente - client _____

ordine - order n: _____ data - date: _____ ref.: _____

annotazioni - notes _____

➔➔ **2** SCELTA ARTICOLO / ITEM CHOICE

E' importante consultare prima la scheda tecnica relativa
 It's important to consult before the technical detail

art. **FY40PC**
 mensola / shelf da / from 140 a / to 200 cm

➔➔ **3** SCELTA COLORE / COLOUR SELECTION

CRISTALLO EXTRA_LIGHT
 EXTRA_LIGHT CRYSTAL

bianco - white nero - black

➔➔ **4** SCELTA DETTAGLI / DETAILS SELECTION

FORI RUBINETTERIA / TAP HOLES

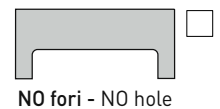
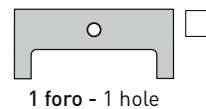
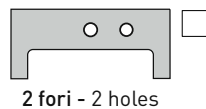
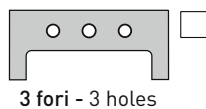

➔➔ **5** SCELTA MISURE / MEASURES

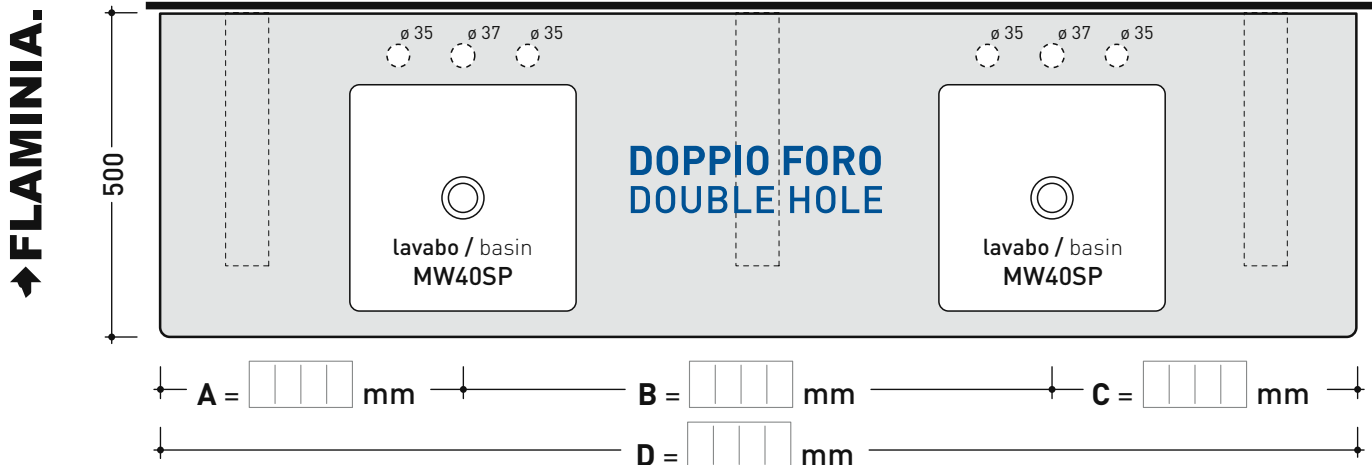
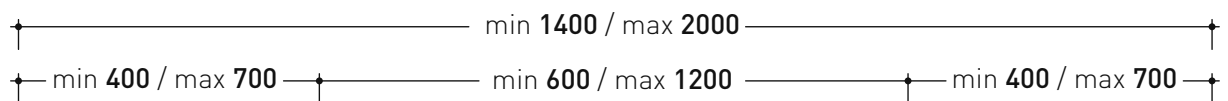

- **A** = misura interasse lavabo da sinistra / left distance of basin.
- **B** = misura interasse lavabo da destra / right distance of basin.
- **C** = misura totale del piano / total length of the shelf.
- verificare sempre che / verify that: **A + B + C = D.**