

2013

## EG170

Free-standing white Crystal-Tech bathtub 170 cm  
(including 4 brass clawfeet and external drainage system)

Complements: **Line accessories EVERGREEN**  
**Line taps EVERGREEN**

Package dim. **200 x 100 x 69 cm** | Weight **75 kg** | Pz. Pallet n° **1**

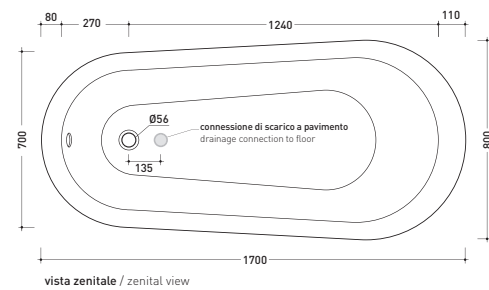
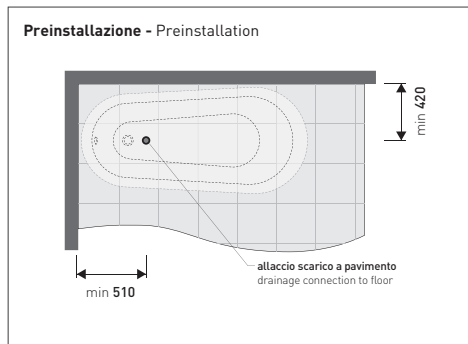

**Capacità Max / Max Capacity 165 L.**  
**Peso Netto / Net Weight 60 Kg.**

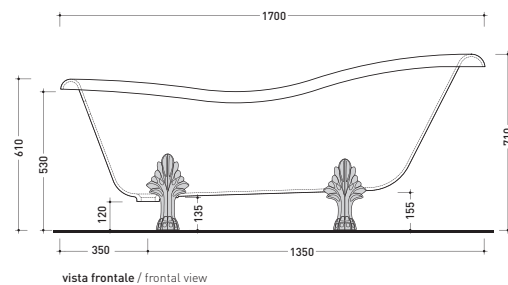
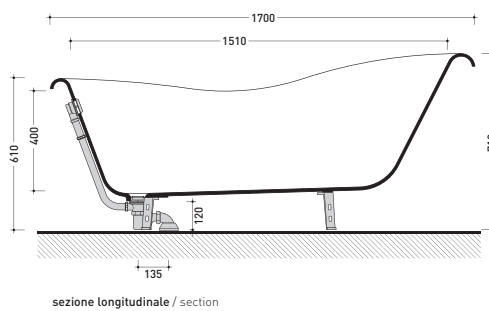
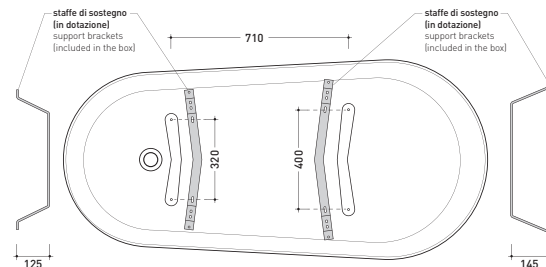

size in mm

october 2016

**CRYSTAL-TECH:** glossy finish

white



**BRASS:** glossy finish

chrome



gold



bronze



white



2013

## EG170

Free-standing white Crystal-Tech bathtub 170 cm  
(including 2 stainless support and external drainage system)

Complements: **Line accessories EVERGREEN**  
**Line taps EVERGREEN**

Package dim. **200 x 100 x 69 cm** | Weight **75 kg** | Pz. Pallet n° **1**

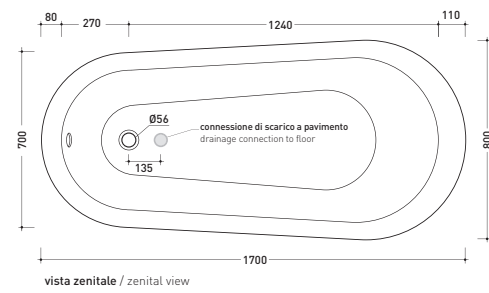
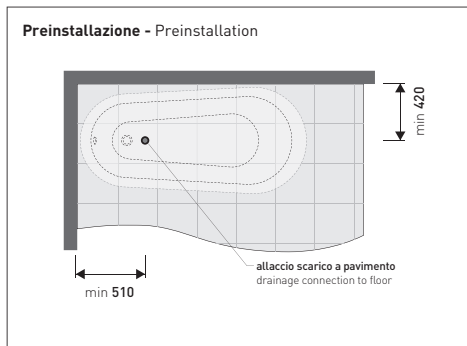

**Capacità Max / Max Capacity 165 L.**  
**Peso Netto / Net Weight 60 Kg.**

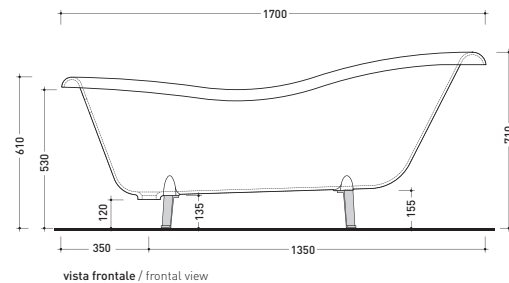
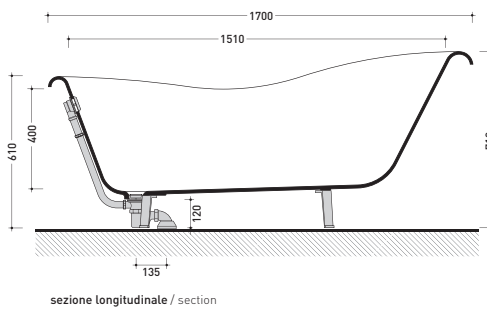
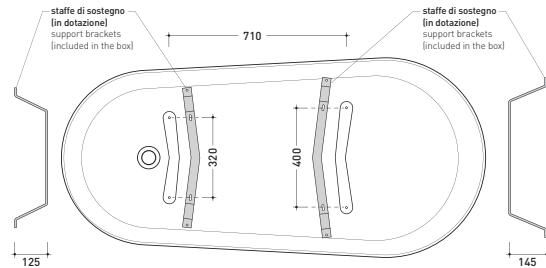

size in mm

october 2016

**CRYSTAL-TECH:** glossy finish

white



**BRASS:** glossy finish

chrome



gold



white



design **FLAMINIA DESIGN TEAM**

2013

## EG80S

Mirror 80x80 cm with wooden frame

Package dim.

Weight **10 kg**

Pz. Pallet n° -

## EG100S

Riversible mirror 100x80 cm with wooden frame

Package dim.

Weight **12 kg**

Pz. Pallet n° -

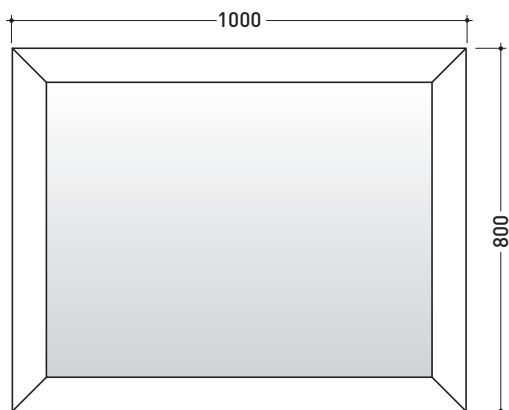

**EG100S**

vista frontale / frontal view



vista laterale / lateral view

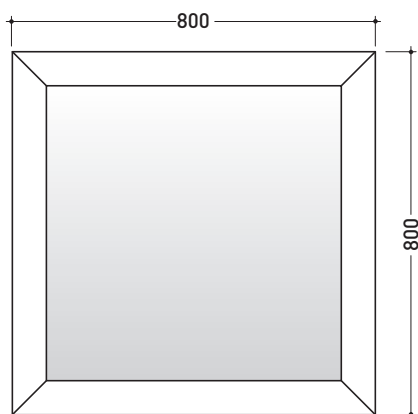

**EG80S**

vista frontale / frontal view



vista laterale / lateral view

size in mm

october 2016

**LACQUERED WOOD:** matt finish

white

black



2013

## EGPF

Toilet brush holder

Complements: **Line taps** EVERGREEN

Package dim.

Weight **0,9 kg**

Pz. Pallet n° -

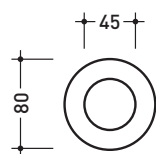

vista zenitale / zenital view

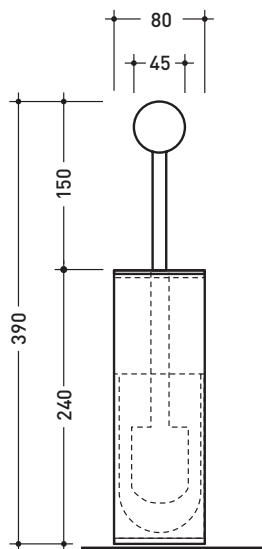

vista frontale / frontal view

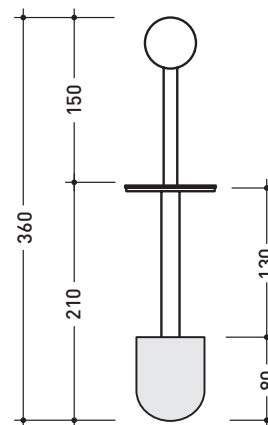

scopino / toilet brush

size in mm

october 2016

**BRASS:** glossy finish

chrome

gold



2013

## EGPR

Paper holder

Complements: **Line taps** EVERGREEN

Package dim.

Weight **0,4 kg**

Pz. Pallet n° -

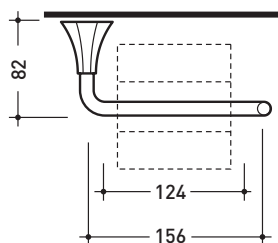

vista zenitale / zenital view

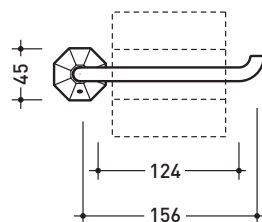

vista frontale / frontal view

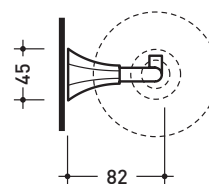

vista laterale / lateral view

size in mm

october 2016

BRASS: glossy finish

chrome

gold



2013

## EGPS

Ceramic soap holder

Complements: **Line taps EVERGREEN**

Package dim.

Weight **0,6 kg**

Pz. Pallet n° -

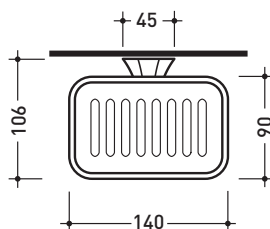

vista zenitale / zenital view

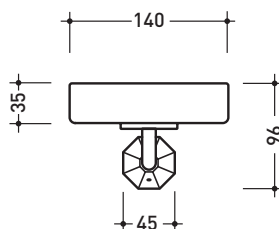

vista frontale / frontal view

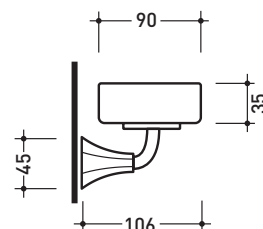

vista laterale / lateral view

size in mm

october 2016

**CERAMIC:** glossy finish

white



**BRASS:** glossy finish

chrome

gold



2013

## EGPB

Ceramic glass holder

Complements: **Line taps EVERGREEN**

Package dim.

Weight **0,7 kg**

Pz. Pallet n° -

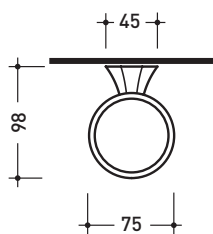

vista zenitale / zenital view

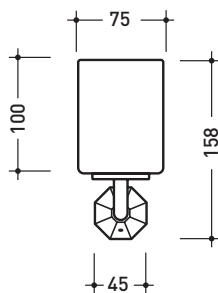

vista frontale / frontal view

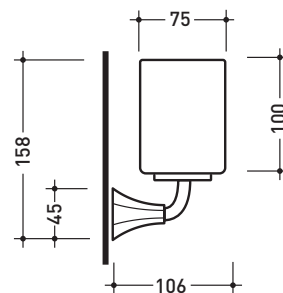

vista laterale / lateral view

size in mm

october 2016

**CERAMIC:** glossy finish

white



**BRASS:** glossy finish

chrome



gold



2013

## EGPA

Towel hook

Complements: **Line taps EVERGREEN**

Package dim.

Weight **0,3 kg**

Pz. Pallet n° -

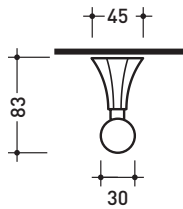

vista zenitale / zenital view

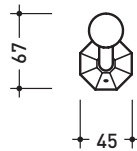

vista frontale / frontal view

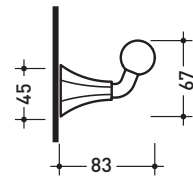

vista laterale / lateral view

size in mm

october 2016

**BRASS:** glossy finish

chrome

gold





2013

## EG30

Towel holder 30 cm

Package dim.	Weight <b>0,9 kg</b>	Pz. Pallet n° -
--------------	----------------------	-----------------

## EG45

Towel holder 45 cm

Package dim.	Weight <b>1 kg</b>	Pz. Pallet n° -
--------------	--------------------	-----------------

## EG60

Towel holder 60 cm

Package dim.	Weight <b>1,2 kg</b>	Pz. Pallet n° -
--------------	----------------------	-----------------

Complements: **Line taps EVERGREEN**

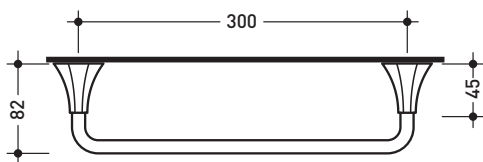

vista zenitale / zenital view

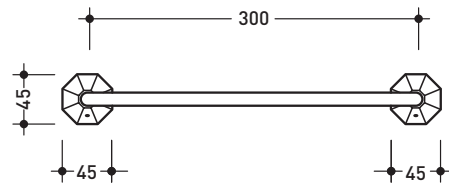

vista frontale / frontal view

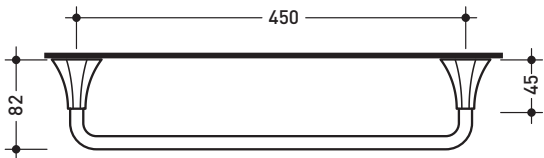

vista zenitale / zenital view

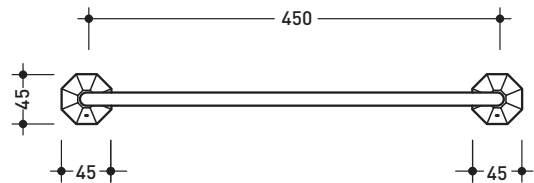

vista frontale / frontal view

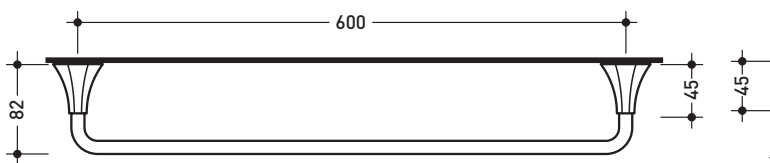

vista zenitale / zenital view

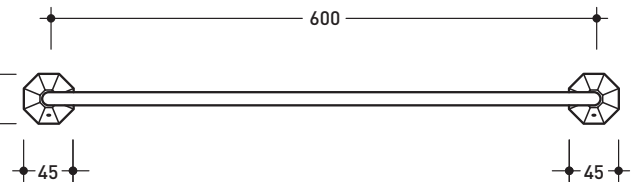

vista frontale / frontal view

size in mm

october 2016

**BRASS:** glossy finish

chrome

gold



2013

## EGAN

Towel ring

Complements: **Line taps EVERGREEN**

Package dim. **18 x 17 x 9 cm** | Weight **1 kg** | Pz. Pallet n° -

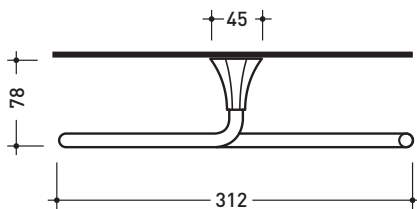

vista zenitale / zenital view

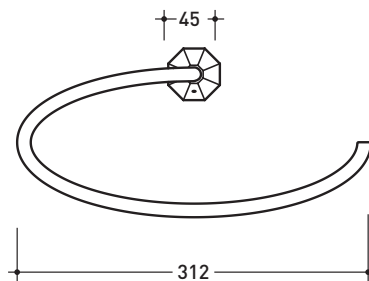

vista frontale / frontal view

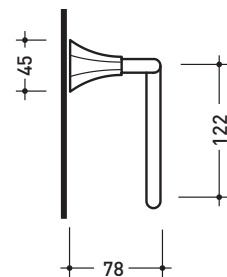

vista laterale / lateral view

size in mm

october 2016

**BRASS:** glossy finish

chrome

gold



2013

## EG45M

Shelf 45 cm with glass top

Package dim.	Weight <b>1,1 kg</b>	Pz. Pallet n° -
--------------	----------------------	-----------------

## EG60M

Shelf 60 cm with glass top

Package dim.	Weight <b>1,3 kg</b>	Pz. Pallet n° -
--------------	----------------------	-----------------

Complements: **Line taps EVERGREEN**

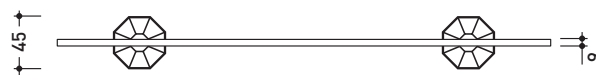

vista zenitale / zenital view

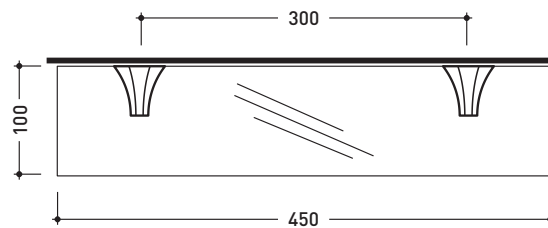

vista frontale / frontal view

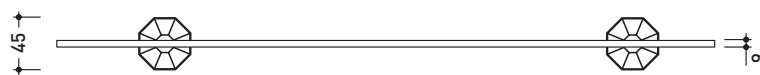

vista zenitale / zenital view

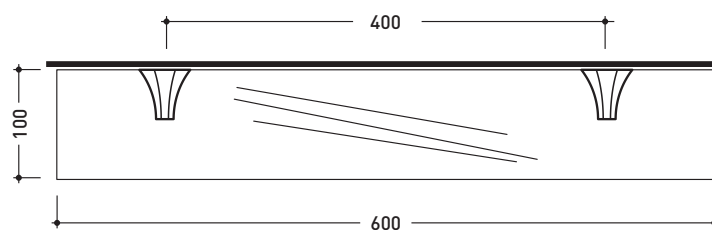

vista frontale / frontal view

size in mm

october 2016

**BRASS:** glossy finish

chrome

gold



2013

## EG203

Single lever basin mixer (stop&go drain included)

Complements: **Line accessories** EVERGREEN

Package dim.

Weight **1,9 kg**

Pz. Pallet n° -

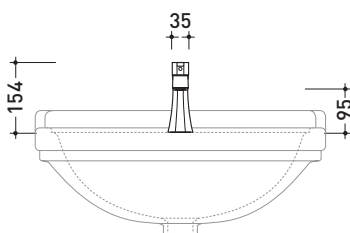

vista frontale / frontal view

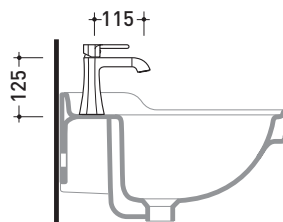

vista laterale / lateral view

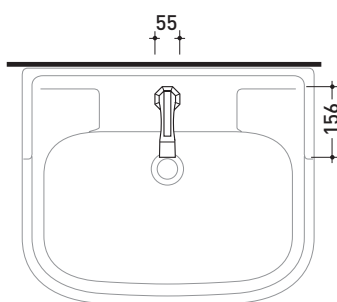

vista zenitale / zenital view

size in mm

october 2016

**BRASS:** glossy finish

chrome

gold



2013

## EG200

Double lever basin mixer (stop&go drain included)

Complements: **Line accessories** EVERGREEN

Package dim.

Weight **2,8 kg**

Pz. Pallet n° -

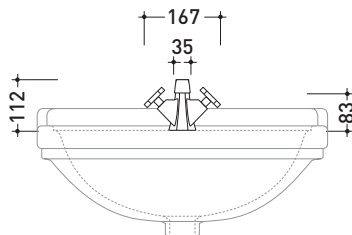

vista frontale / frontal view

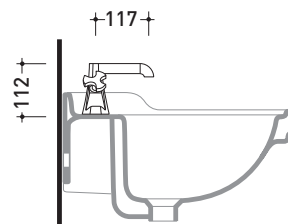

vista laterale / lateral view

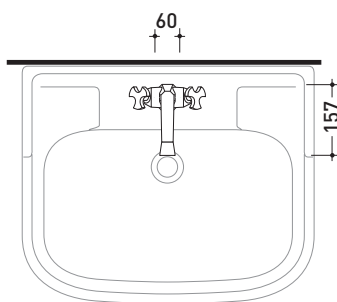

vista zenitale / zenital view

size in mm

october 2016

**BRASS:** glossy finish

chrome

gold



2013

## EG201

Three-holes tap basin (stop&go drain included)

Complements: **Line accessories** EVERGREEN

Package dim.

Weight **4,3 kg**

Pz. Pallet n° -

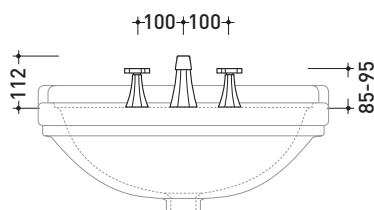

vista frontale / frontal view

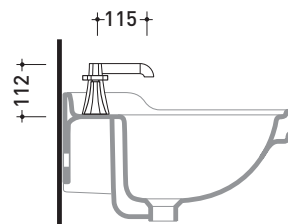

vista laterale / lateral view

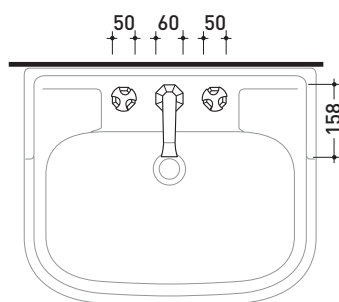

vista zenitale / zenital view

size in mm

october 2016

**BRASS:** glossy finish

chrome

gold



2013

## EG390

Three-holes high tap basin mixer (stop&go drain included)

Complements: **Line accessories** EVERGREEN

Package dim.

Weight **4,8 kg**

Pz. Pallet n° -

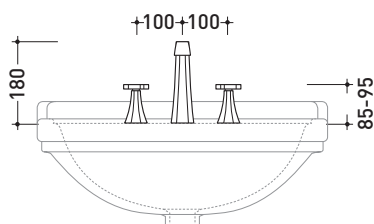

vista frontale / frontal view

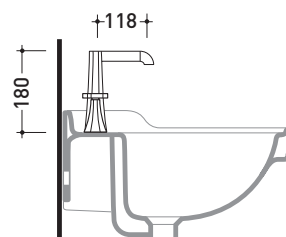

vista laterale / lateral view

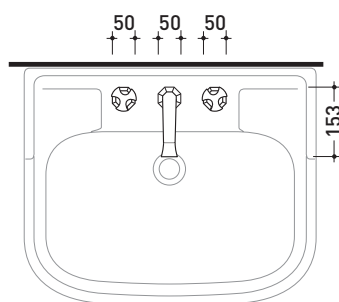

vista zenitale / zenital view

size in mm

october 2016

**BRASS:** glossy finish

chrome

gold



2013

## EG206

Wall-mounted double lever basin mixer (stop&go drain included)

Complements: **Line accessories** EVERGREEN

Package dim.

Weight **4,6 kg**

Pz. Pallet n° -

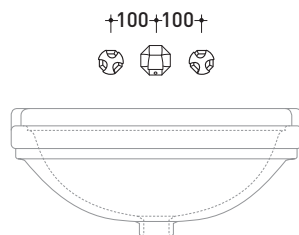

vista frontale / frontal view

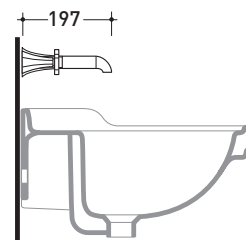

vista laterale / lateral view

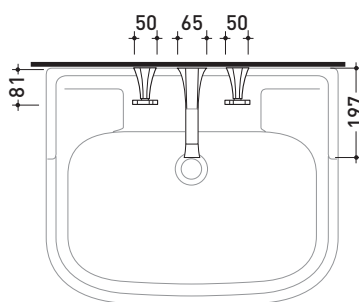

vista zenitale / zenital view

size in mm

october 2016

**BRASS:** glossy finish

chrome

gold





2013

## EG223

Single lever bidet mixer (stop&go drain included)

Complements: **Line accessories** EVERGREEN

Package dim.

Weight **1,8 kg**

Pz. Pallet n° -

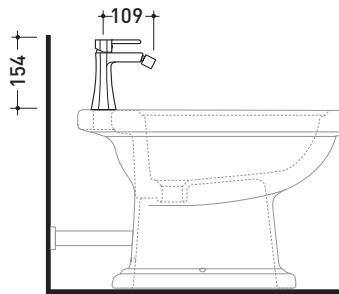

vista laterale / lateral view

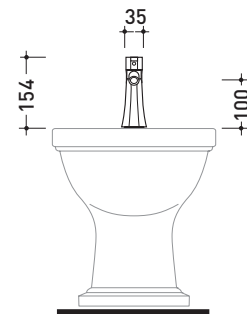

vista frontale / frontal view

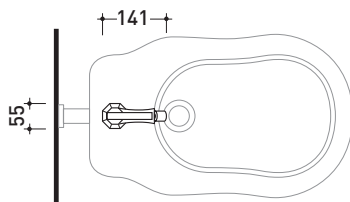

vista zenitale / zenital view

size in mm

october 2016

**BRASS:** glossy finish

chrome

gold



2013

## EG220

Duble lever bidet mixer (stop&go drain included)

Complements: **Line accessories** EVERGREEN

Package dim.

Weight **2,5 kg**

Pz. Pallet n° -

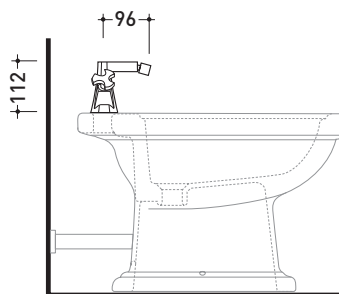

vista laterale / lateral view

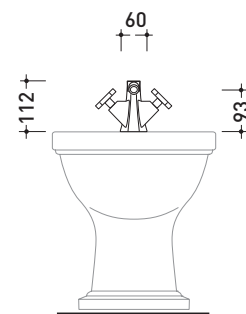

vista frontale / frontal view

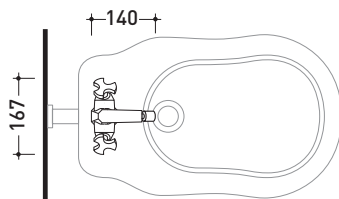

vista zenitale / zenital view

size in mm

october 2016

**BRASS:** glossy finish

chrome

gold



2013

## EG202

Three-holes tap bidet (stop&go drain included)

Complements: **Line accessories** EVERGREEN

Package dim.

Weight **4,7 kg**

Pz. Pallet n° -

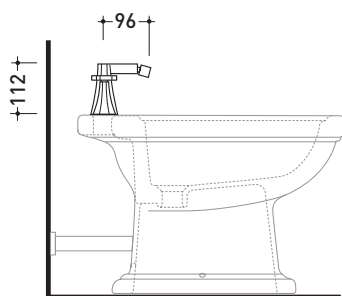

vista laterale / lateral view

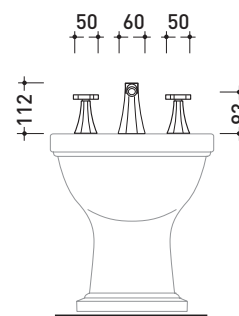

vista frontale / frontal view

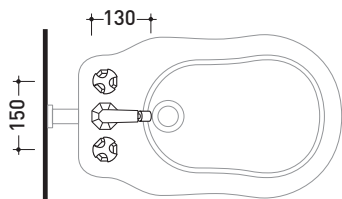

vista zenitale / zenital view

size in mm

october 2016

**BRASS:** glossy finish

chrome

gold



2013

## EG400

Concealed shower mixer

Complements: **Line accessories** EVERGREEN

Package dim.

Weight **1,5 kg**

Pz. Pallet n° -

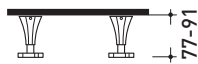

vista zenitale / zenital view

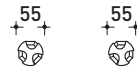

vista frontale / frontal view

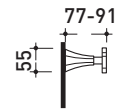

vista laterale / lateral view

size in mm

october 2016

**BRASS:** glossy finish

chrome

gold



2013

## EG310

Concealed shower mixer 2 outlets with diverter

Complements: **Line accessories** EVERGREEN

Package dim.

Weight **2,2 kg**

Pz. Pallet n° -

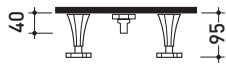

vista zenitale / zenital view



vista frontale / frontal view

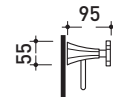

vista laterale / lateral view

size in mm

october 2016

**BRASS:** glossy finish

chrome

gold



2013

## EG150

Hand-shower with wall bracket

Complements: **Line accessories** EVERGREEN

Package dim.

Weight **0,4 kg**

Pz. Pallet n° -

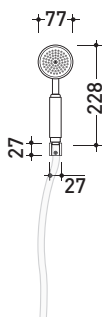

vista frontale / frontal view

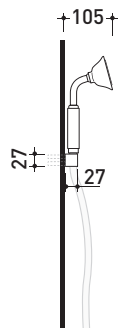

vista laterale / lateral view

size in mm

october 2016

**BRASS:** glossy finish

chrome

gold



2013

## EG350

Shower mixer

Complements: **Line accessories** EVERGREEN

Package dim.

Weight **3 kg**

Pz. Pallet n° -

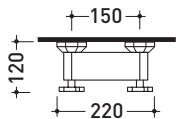

vista zenitale / zenital view

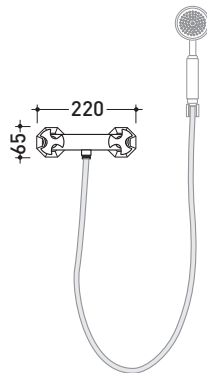

vista frontale / frontal view

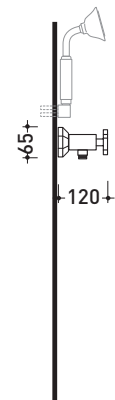

vista laterale / lateral view

size in mm

october 2016

**BRASS:** glossy finish

chrome

gold



2013

## EG450

Hand-shower with riser

Complements: **Line accessories** EVERGREEN

Package dim.

Weight **2,1 kg**

Pz. Pallet n° -

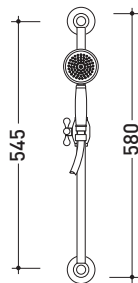

vista frontale / frontal view

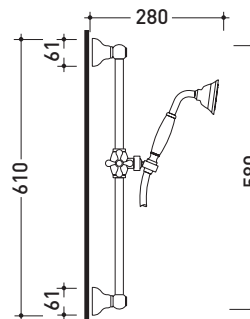

vista laterale / lateral view

size in mm

october 2016

**BRASS:** glossy finish

chrome

gold





2013

## EG550

Shower system complete with shower head and hand-shower  
(shower mixer not included)

Complements: **Line accessories** EVERGREEN

Package dim.

Weight **8 kg**

Pz. Pallet n° -

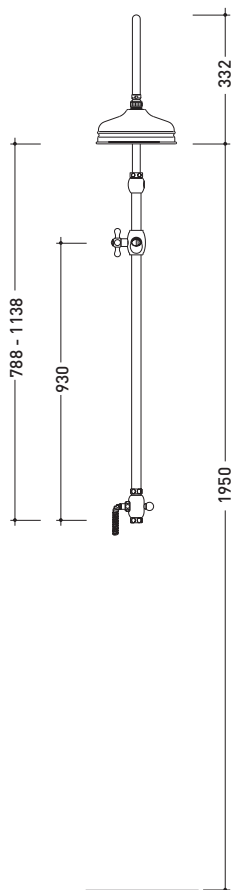

vista frontale / frontal view

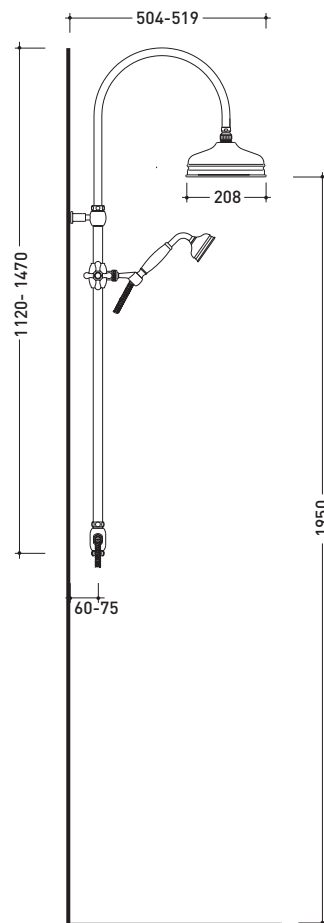

vista laterale / lateral view

size in mm

october 2016

**BRASS:** glossy finish

chrome

gold



2013

## EGBT1

Concealed thermostatic shower mixer 1 outlet

Complements: **Line accessories** EVERGREEN

Package dim.

Weight **5 kg**

Pz. Pallet n° -

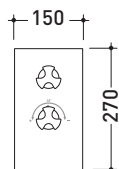

vista frontale / frontal view

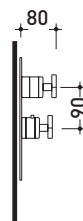

vista laterale / lateral view

size in mm

october 2016

**BRASS:** glossy finish

chrome

gold



2013

## EGBT2

Concealed thermostatic shower mixer 2 outlet

Complements: **Line accessories** EVERGREEN

Package dim.

Weight **6,5 kg**

Pz. Pallet n° -

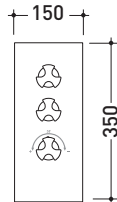

vista frontale / frontal view

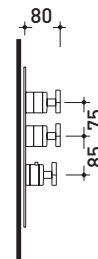

vista laterale / lateral view

size in mm

october 2016

**BRASS:** glossy finish

chrome

gold



2013

## EGBT3

Concealed thermostatic shower mixer 3 outlet

Complements: **Line accessories** EVERGREEN

Package dim.

Weight **9 kg**

Pz. Pallet n° -

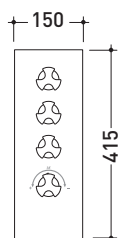

vista frontale / frontal view

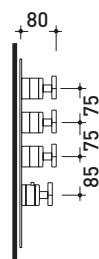

vista laterale / lateral view

size in mm

october 2016

BRASS: glossy finish

chrome

gold



2013

## EGBT4

Concealed thermostatic shower mixer 4 outlet

Complements: **Line accessories** EVERGREEN

Package dim.

Weight **11 kg**

Pz. Pallet n° -



vista frontale / frontal view

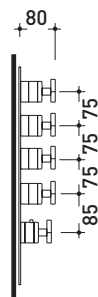

vista laterale / lateral view

size in mm

october 2016

BRASS: glossy finish

chrome

gold



2013

## EG650

Shower head

Complements: **Line accessories** EVERGREEN

Package dim.

Weight **1,2 kg**

Pz. Pallet n° -

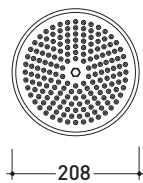

vista dal basso / bottom view

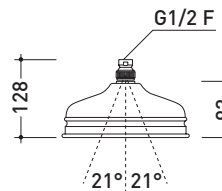

vista frontale / frontal view

size in mm

october 2016

**BRASS:** glossy finish

chrome

gold



2013

## EG418

Wall mounted shower arms

Complements: **Line accessories** EVERGREEN

Package dim.

Weight **0,4 kg**

Pz. Pallet n° -

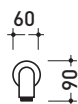

vista frontale / frontal view

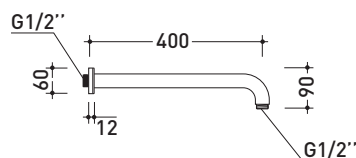

vista laterale / lateral view

size in mm

october 2016

**BRASS:** glossy finish

chrome

gold



2013

## EG250

External bathtub mixer with diverter and hand-shower

Complements: **Line accessories** EVERGREEN

Package dim.

Weight **5,2 kg**

Pz. Pallet n° -

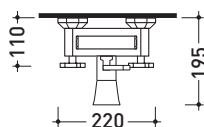

vista zenitale / zenital view

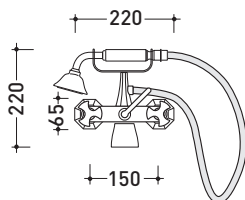

vista frontale / frontal view

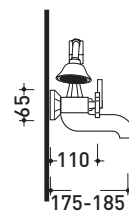

vista laterale / lateral view

size in mm

october 2016

**BRASS:** glossy finish

chrome

gold





2013

## EG700

Floor mounted bathtub mixer with diverter and hand-shower

Complements: **Line accessories** EVERGREEN

Package dim.

Weight **10,5 kg**

Pz. Pallet n° -

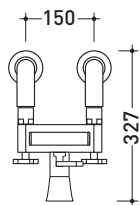
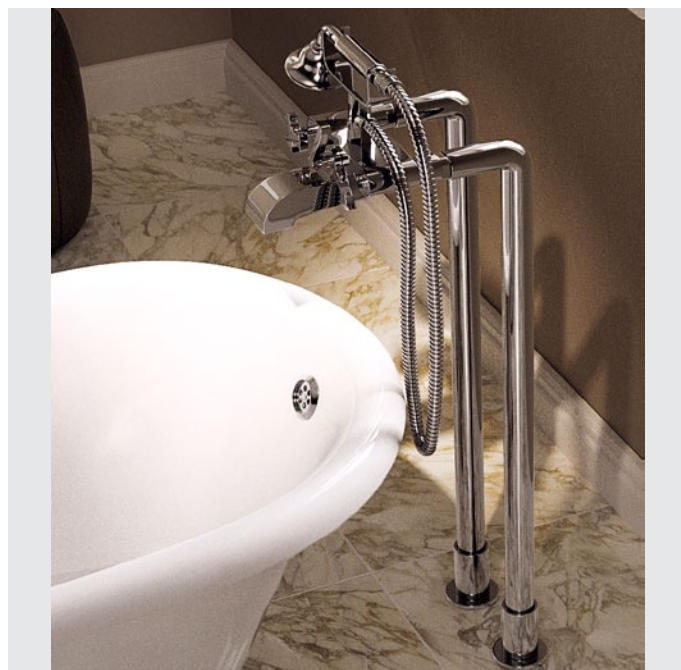

vista zenitale / zenital view

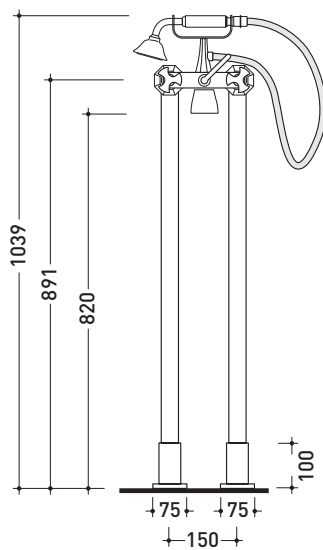

vista frontale / frontal view

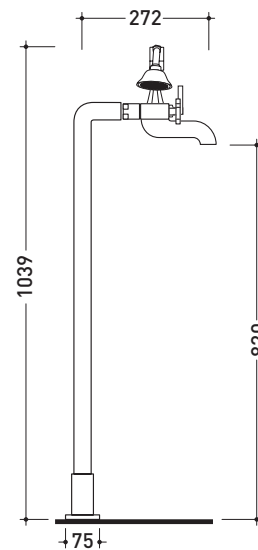

vista laterale / lateral view

size in mm

october 2016

**BRASS:** glossy finish

chrome

gold

