

2017

BX423 L 70 x P 50 x H 50

Base sospesa H50 - 1 CASSETTO

TOP ESCLUSO

Complementi: Specchi linea SIMPLE, MAKE-UP, APP

Dim. Imballo

Peso **33,1 kg**

Pz. Pallet n° -



CE

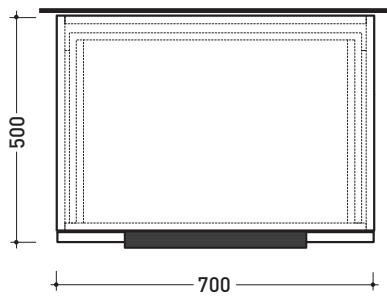

vista zenitale / zenital view

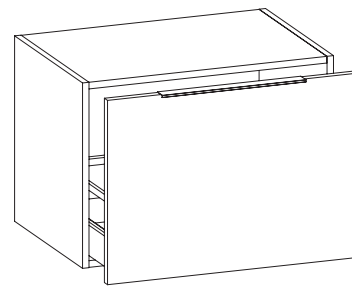

assonometria / axonometry

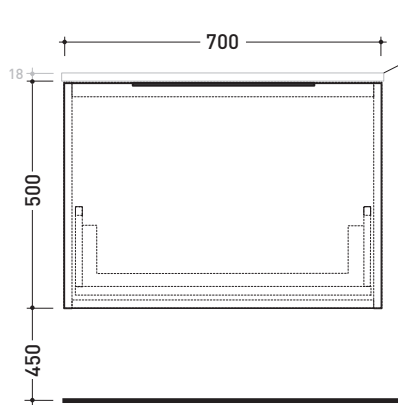

vista frontale / frontal view

TOP ESCLUSO
TOP NOT INCLUDED

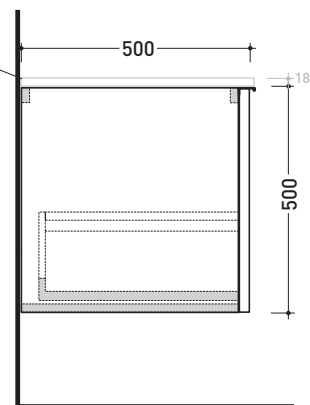

sezione longitudinale / section

dimensioni in mm

LEGNO: finiture



OK Arly



OJ Bianco



OJ Grigio



OJ Canapa

2017

BX427 L 85 x P 50 x H 50

Base sospesa H50 - 1 CASSETTO

TOP ESCLUSO

Complementi: Specchi linea SIMPLE, MAKE-UP, APP

Dim. Imballo

Peso **24,4 kg**

Pz. Pallet n° -



CE

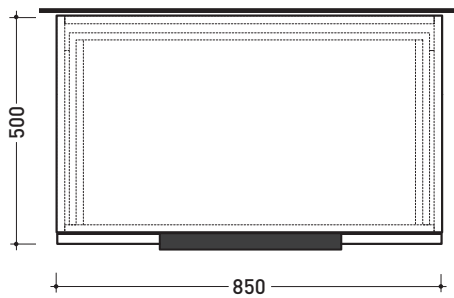

vista zenitale / zenital view

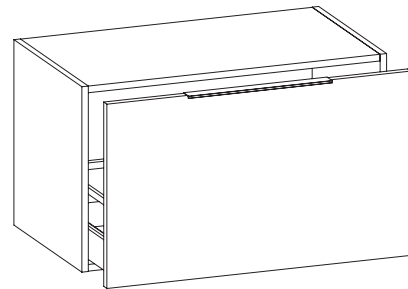

assonometria / axonometry

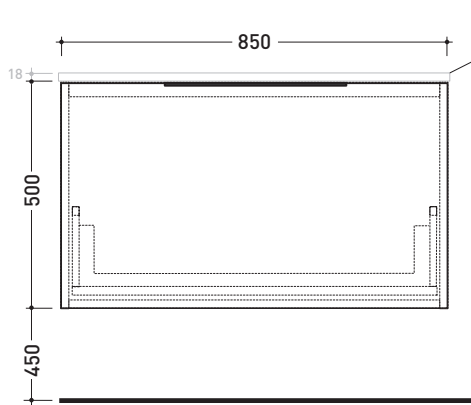

vista frontale / frontal view

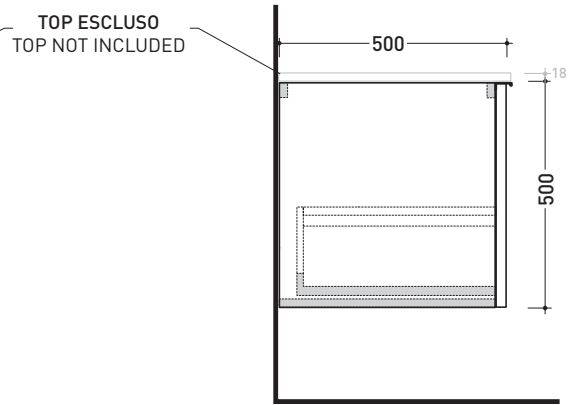

sezione longitudinale / section

dimensioni in mm

LEGNO: finiture



OK Arly



OJ Bianco



OJ Grigio



OJ Canapa

2017

BX431 L 95 x P 50 x H 50

Base sospesa H50 - 1 CASSETTO

TOP ESCLUSO

Complementi: Specchi linea SIMPLE, MAKE-UP, APP

Dim. Imballo

Peso **35,7 kg**

Pz. Pallet n° -



CE

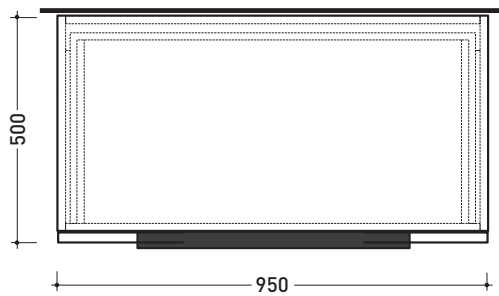

vista zenitale / zenital view

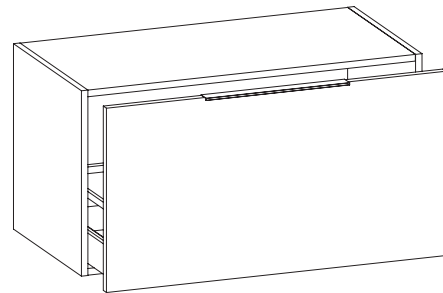

assonometria / axonometry

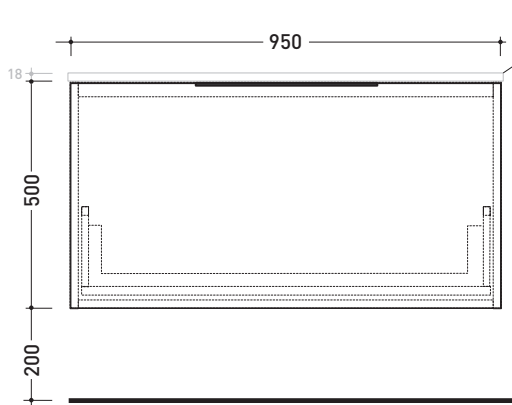

vista frontale / frontal view

TOP ESCLUSO
TOP NOT INCLUDED

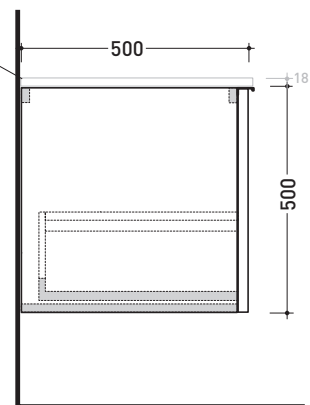

sezione longitudinale / section

dimensioni in mm

LEGNO: finiture



OK Arly



OJ Bianco



OJ Grigio



OJ Canapa

2017

BX435 L 105 x P 50 x H 50

Base sospesa H50 - 1 CASSETTO

TOP ESCLUSO

Complementi: Specchi linea SIMPLE, MAKE-UP, APP

Dim. Imballo

Peso **38,7 kg**

Pz. Pallet n° -



CE

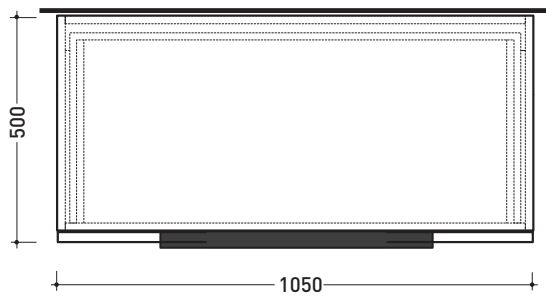

vista zenitale / zenital view

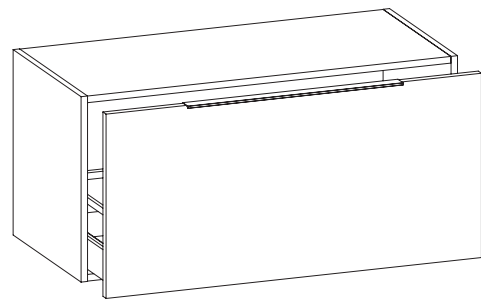

assonometria / axonometry

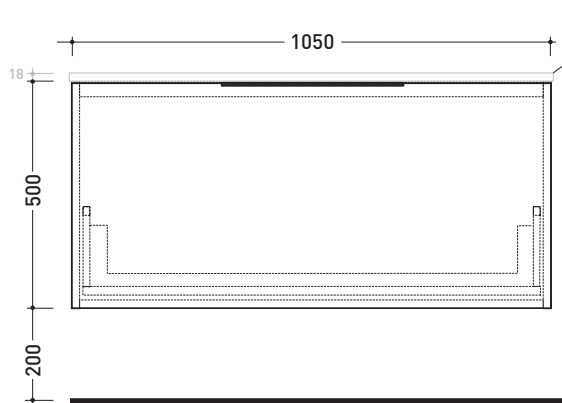

vista frontale / frontal view

TOP ESCLUSO
TOP NOT INCLUDED

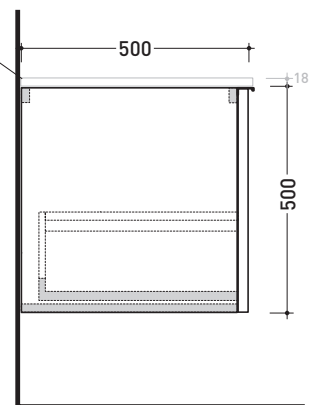

sezione longitudinale / section

dimensioni in mm

LEGNO: finiture



OK Arly



OJ Bianco



OJ Grigio



OJ Canapa

ESEMPI DI COMPOSIZIONI

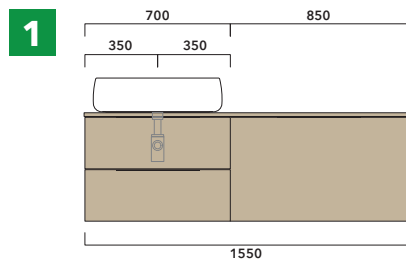

1 | profondità cm 50:
n.1 **BX809** + n.1 **BX427** + **BXPR51** cm 155

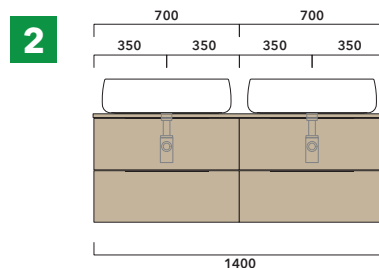

2 | profondità cm 50:
n.2 **BX809** + **BXPR51** cm 140

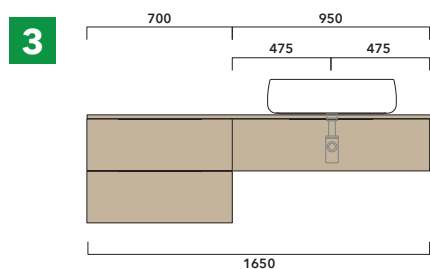

3 | profondità cm 50:
n.1 **BX425** + n. 1 **BX995** + **BXPR51** cm 165

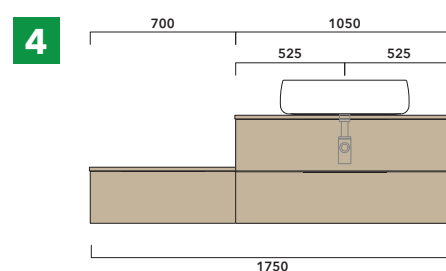

4 | profondità cm 50:
n.1 **BX297** + n. 1 **BX839** + **BXPR51** cm 70 +
BXPR51 cm 105

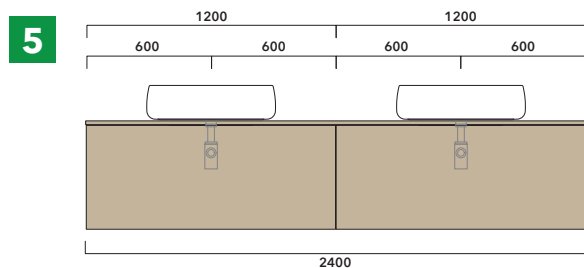

5 | profondità cm 50:
n.2 **BX945** + **BXPR51** cm 240

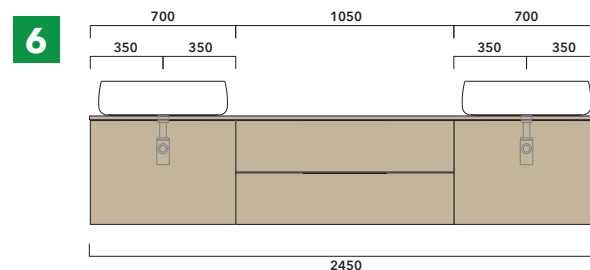

6 | profondità cm 50:
n.2 **BX805** + n.1 **BX437** + **BXPR51** cm 245

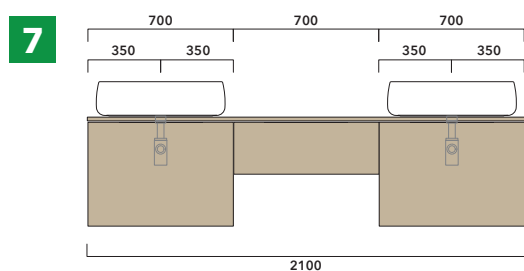

7 | profondità cm 50:
n.2 **BX805** + n. 1 **BX297** + **BXPR51** cm 210

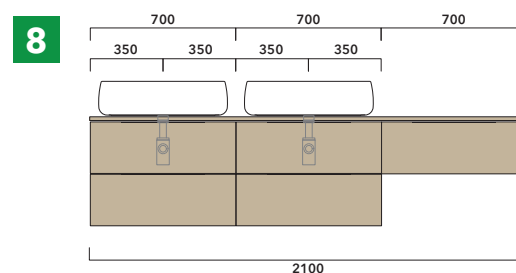

8 | profondità cm 50:
n.2 **BX808** + n. 1 **BX297** + **BXPR51** cm 210

➔ **FLAMINIA.** MODULO PER LA REALIZZAZIONE DELLE COMPOSIZIONI MOBILI **BOX**
CUSTOMIZED COMPOSITION FORM FOR **BOX** UNITS



E' obbligatorio fotocopiare questa pagina, compilarla con cura e allegarla all'ordine.
It is compulsory to photocopy this page, carefully fill in and attach to the order.

➔➔ **1** DETTAGLI ORDINE / ORDER DETAILS

ordinante - buyer _____ cliente - client _____

ordine - order n: _____ data - date: _____ ref.: _____

annotazioni - notes _____

➔➔ **2** PROFONDITÀ MOBILE / UNIT DEPTH É importante consultare il listino prezzi / It's important to consult price list

CM 37

CM 50

➔➔ **3** DISEGNO / DRAWING



➔➔ **4** ELENCO ARTICOLI / ARTICLE LIST É importante consultare il listino prezzi / It's important to consult price list

art. _____ dim. _____ art. _____ dim. _____

art. _____ dim. _____ art. _____ dim. _____

art. _____ dim. _____ art. _____ dim. _____

➔➔ **5** LAVABO DA APPOGGIO / COUTERTOP BASIN

FLAMINIA lavabo/basin art. _____

NO FLAMINIA lavabo/basin
(allegare scheda tecnica / enclose a technical drawing)

➔➔ **6** SCELTA FINITURA / FINISH SELECTION

OK ARLY

OJ BIANCO

OJ GRIGIO

OJ CANAPA