

2017

## BX424 L 70 x P 37 x H 50

Base sospesa H50 - 2 CASSETTI

**TOP ESCLUSO**

Complementi: Specchi linea SIMPLE, MAKE-UP, APP

Dim. Imballo

Peso **20,5 kg**

Pz. Pallet n° -



CE

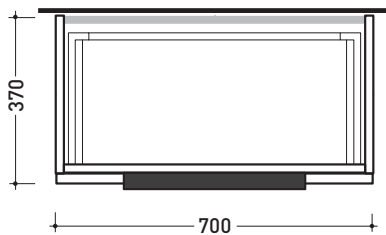

vista zenitale / zenital view

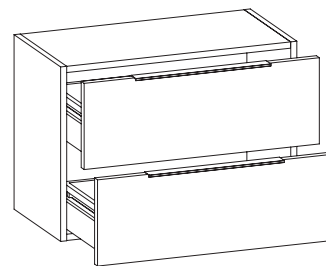

assonometria / axonometry

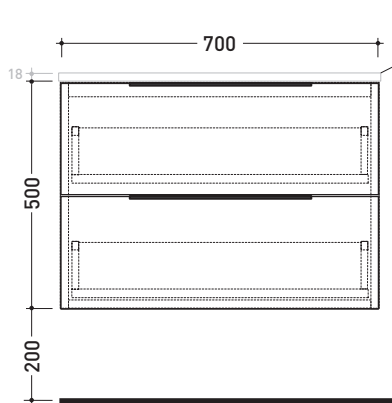

vista frontale / frontal view

TOP ESCLUSO  
TOP NOT INCLUDED

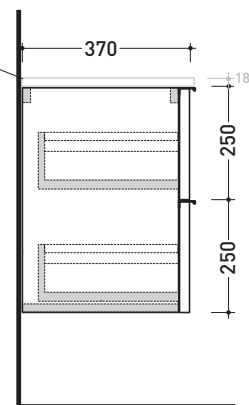

sezione longitudinale / section

dimensioni in mm

LEGNO: finiture



OK Arly



OJ Bianco



OJ Grigio



OJ Canapa

2017

## BX428 L 85 x P 37 x H 50

Base sospesa H50 - 2 CASSETTI

**TOP ESCLUSO**

Complementi: Specchi linea SIMPLE, MAKE-UP, APP

Dim. Imballo

Peso **25,9 kg**

Pz. Pallet n° -



CE

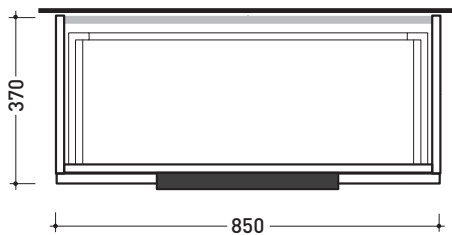

vista zenitale / zenital view

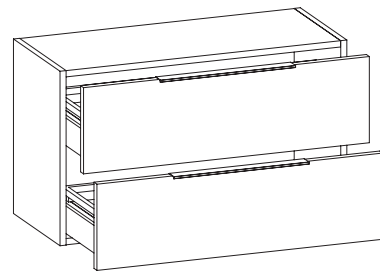

assonometria / axonometry

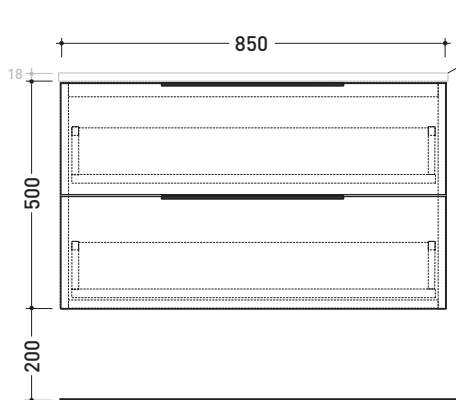

vista frontale / frontal view

TOP ESCLUSO  
TOP NOT INCLUDED

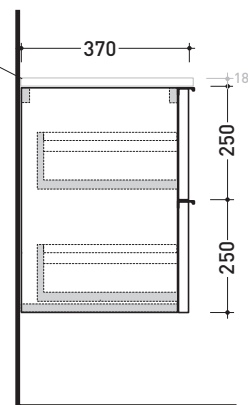

sezione longitudinale / section

dimensioni in mm

LEGNO: finiture



OK Arly



OJ Bianco



OJ Grigio



OJ Canapa

2017

## BX432 L 95 x P 37 x H 50

Base sospesa H50 - 2 CASSETTI

**TOP ESCLUSO**

Complementi: Specchi linea SIMPLE, MAKE-UP, APP

Dim. Imballo

Peso **26,3 kg**

Pz. Pallet n° -



CE

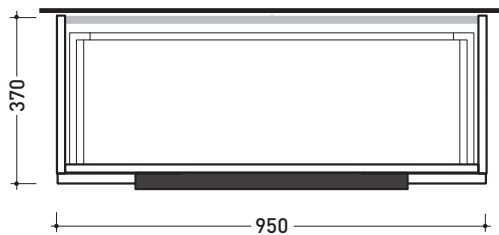

vista zenitale / zenital view

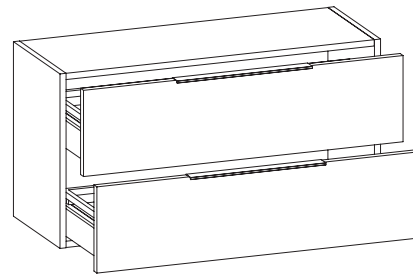

assonometria / axonometry

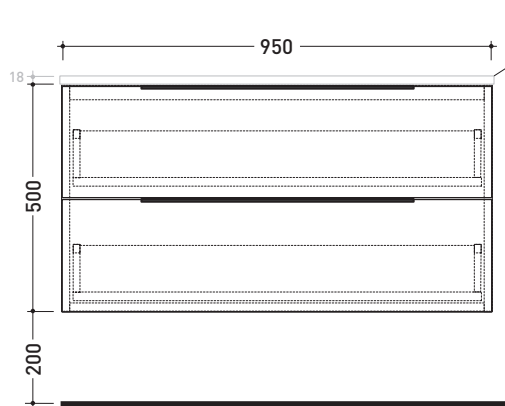

vista frontale / frontal view

TOP ESCLUSO  
TOP NOT INCLUDED

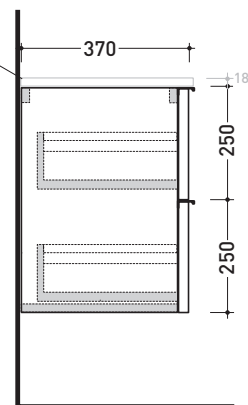

sezione longitudinale / section

dimensioni in mm

LEGNO: finiture



OK Arly



OJ Bianco



OJ Grigio



OJ Canapa

2017

## BX436 L 105 x P 37 x H 50

Base sospesa H50 - 2 CASSETTI

**TOP ESCLUSO**

Complementi: Specchi linea SIMPLE, MAKE-UP, APP

Dim. Imballo

Peso **27,5 kg**

Pz. Pallet n° -



CE

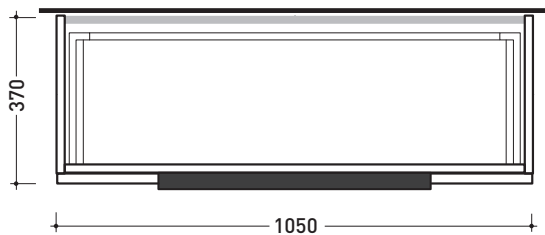

vista zenitale / zenital view

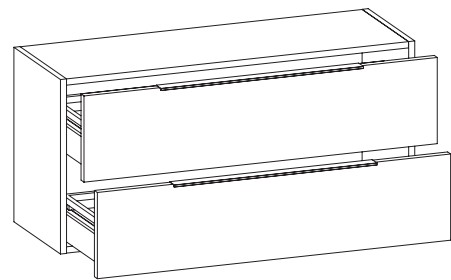

assonometria / axonometry

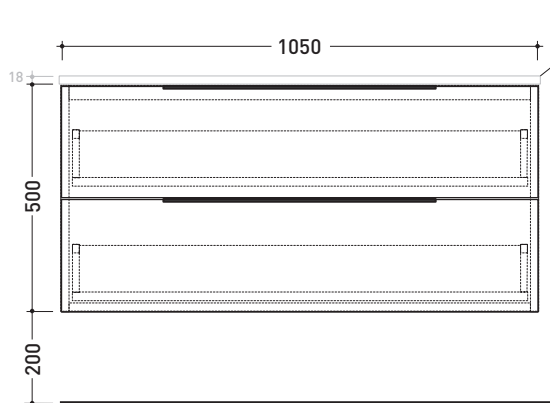

vista frontale / frontal view

TOP ESCLUSO  
TOP NOT INCLUDED

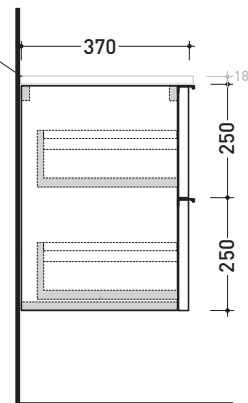

sezione longitudinale / section

dimensioni in mm

LEGNO: finiture



OK Arly



OJ Bianco



OJ Grigio



OJ Canapa

<http://www.ceramicaflaminia.it/it/products/342-box>

©ceramicaflaminiaspa - è vietata la copia, la pubblicazione e la riproduzione anche parziale se non autorizzata

maggio 2019



## ESEMPI DI COMPOSIZIONI

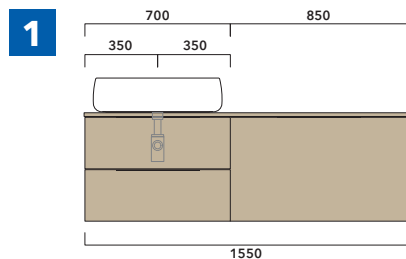

**1** | profondità cm 37:  
n.1 **BX808** + n.1 **BX426** + **BXPR38** cm 155

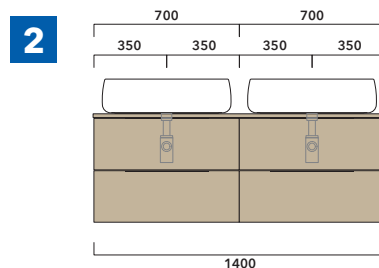

**2** | profondità cm 37:  
n.2 **BX808** + **BXPR38** cm 140

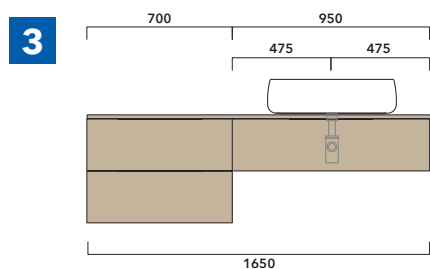

**3** | profondità cm 37:  
n.1 **BX424** + n. 1 **BX994** + **BXPR38** cm 165

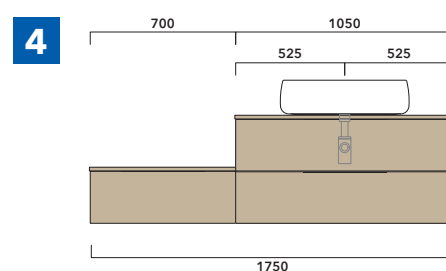

**4** | profondità cm 37:  
n.1 **BX296** + n. 1 **BX838** + **BXPR38** cm 70 +  
**BXPR38** cm 105

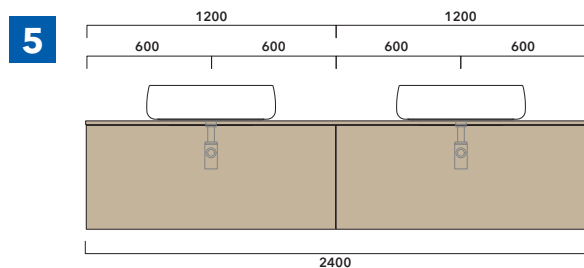

**5** | profondità cm 37:  
n.2 **BX944** + **BXPR38** cm 240

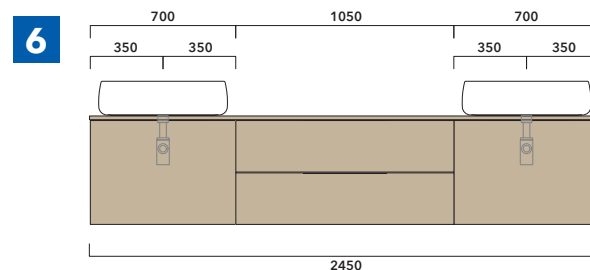

**6** | profondità cm 37:  
n.2 **BX804** + n.1 **BX436** + **BXPR38** cm 245

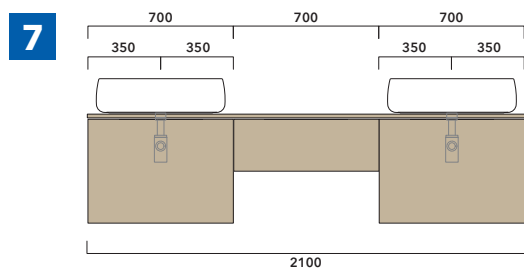

**7** | profondità cm 37:  
n.2 **BX804** + n. 1 **BX296** + **BXPR38** cm 210

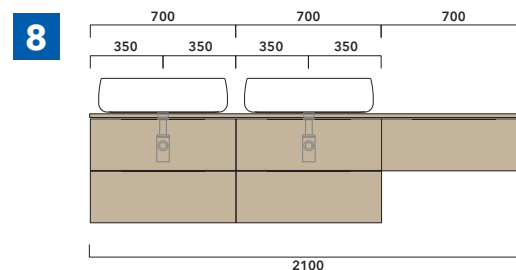

**8** | profondità cm 37:  
n.2 **BX808** + n. 1 **BX296** + **BXPR38** cm 210

➔ **FLAMINIA.** MODULO PER LA REALIZZAZIONE DELLE COMPOSIZIONI MOBILI **BOX**  
CUSTOMIZED COMPOSITION FORM FOR **BOX** UNITS



**E' obbligatorio fotocopiare questa pagina, compilarla con cura e allegarla all'ordine.**  
It is compulsory to photocopy this page, carefully fill in and attach to the order.

➔➔ **1** **DETTAGLI ORDINE / ORDER DETAILS**

ordinante - buyer \_\_\_\_\_ cliente - client \_\_\_\_\_

ordine - order n: \_\_\_\_\_ data - date: \_\_\_\_\_ ref.: \_\_\_\_\_

annotazioni - notes \_\_\_\_\_

➔➔ **2** **PROFONDITÀ MOBILE / UNIT DEPTH** É importante consultare il listino prezzi / It's important to consult price list

CM 37

CM 50

➔➔ **3** **DISEGNO / DRAWING**



➔➔ **4** **ELENCO ARTICOLI / ARTICLE LIST** É importante consultare il listino prezzi / It's important to consult price list

art. \_\_\_\_\_ dim. \_\_\_\_\_ art. \_\_\_\_\_ dim. \_\_\_\_\_

art. \_\_\_\_\_ dim. \_\_\_\_\_ art. \_\_\_\_\_ dim. \_\_\_\_\_

art. \_\_\_\_\_ dim. \_\_\_\_\_ art. \_\_\_\_\_ dim. \_\_\_\_\_

➔➔ **5** **LAVABO DA APPOGGIO / COUTERTOP BASIN**

FLAMINIA lavabo/basin art. \_\_\_\_\_

**NO FLAMINIA lavabo/basin**  
(allegare scheda tecnica / enclose a technical drawing)

➔➔ **6** **SCELTA FINITURA / FINISH SELECTION**

OK ARLY

OJ BIANCO

OJ GRIGIO

OJ CANAPA